

How to fit and operate your Perfect Fit blind

You should have:

First check you've got all the fittings that come with your Perfect Fit blind.

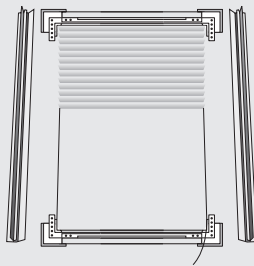

Perfect Fit frame and blind

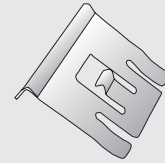

Brackets: amount to suit size of blind

Getting started

- Unpack the blind and frame. Please ensure you've located the brackets before disposing of the packaging.
- Please read the following instructions carefully before you start fitting your blind.

Stage 1: Put the frame together

1

Lay all parts of the frame/blind out face down on a clean even surface. Next unravel the side guide cords and control cords which will be wrapped around your blind.

Your blind will be attached to the top and bottom parts of the frame by side guide cords.

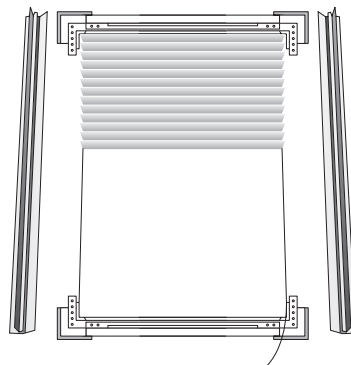

2

Connect the left-hand side of the frame to the exposed arm on the bottom left-hand corner and apply pressure until it feels secure. Repeat the process on the top left-hand corner joint.

Follow the same Procedure for the right hand side of the frame.

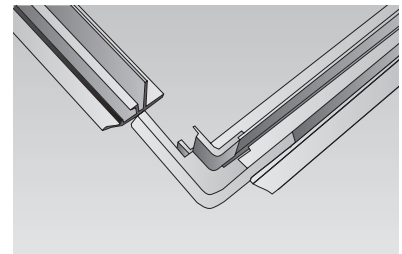

3

Your **Perfect Fit** frame and blind are ready to fit.

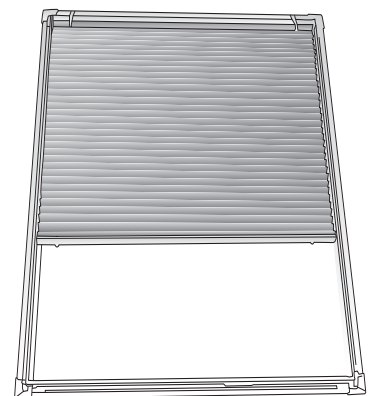

Safety tips:

There are things that you can do to reduce risk in your home.

- Move beds, cots and furniture away from the window.
- Do not let cords or chains hang loose. Make sure they are kept out of reach of children at all times.
- Do not tie loose cords and chains together.
- Check the condition of all safety devices if not used regularly and replace if the device is faulty.
- Replacements can be ordered on makeitchildsafe.co.uk

Operating your blind:

Operating your blind is easy. Just follow these instructions.

PERFECT FIT: Pleated blind

- Simply raise and lower the blind to the desired position by firmly holding the thumb tab.
- We recommend opening and closing your blind regularly to maintain defined pleats in the fabric.

PERFECT FIT: Venetian blind

- Simply raise and lower the blind to the desired position by firmly holding the thumb tab.
- To adjust the angle of the slats, twist the wand.
- Slats need to be open when raising or lowering the blind.

Stage 2: Attach the brackets

1

You need to push the brackets between your window pane and the rubber window seal.

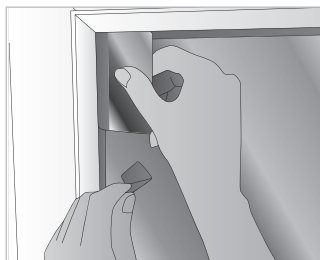

✘ Top tip

You can use a credit/debit card as a template to find the correct position for the brackets. Place the card length ways along the side of the window in each corner, and line up the bracket with the end of the card as shown.

2

Fit any intermediate brackets accordingly. Two extra brackets will be supplied for blinds over 120cm drop, these should be positioned approx mid way down the drop of the blind one on each side. These need to be lined up with the bracket hole positions on the **Perfect Fit** frame.

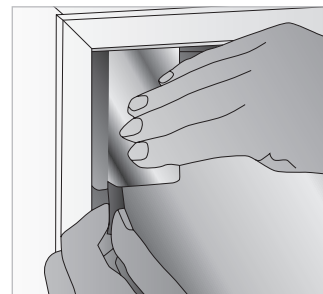

✘ Top tip

If you find that the brackets are difficult to place behind the window seal, you can use a spot of washing up liquid as lubricant on the flat part of the bracket. Once all the brackets are fitted, clean any excess washing up liquid from the window surface.

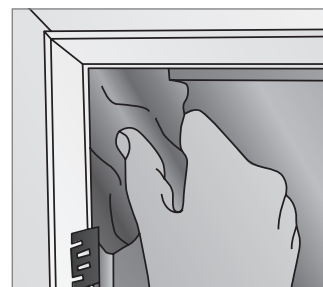

Stage 3: Attach the frame and blind to the window

1

Line up the holes in the **Perfect Fit** frame with the brackets.



2

Firmly press the frame onto each bracket one side at a time.



Apply push fit cover caps to each corner of the blind. Your frame and blind are now installed.

Stage 4: Using the blind

1

If your blind has slackened and won't sit flush to the top of the window, you'll need to adjust the tension in the shoe.



Do this by pulling out the cord and tying a new knot 5mm further along the cord. Do not cut off excess cord before trying the blind operation. Then replace the shoe to its original position.



2

If your blind does not sit level,



push the blind to the top of the window



and pull back down.

